

V604 Programmable Universal Transmitter



Fig1. Transmitter V604
in housing S17 clipped onto a top-hat rail



Fig2. Transmitter V604
in housing S17 screw hole mounting
brackets pulled out.

Application

The universal transmitter V 604 (Figures 1 and 2) converts the input variable – a DC current or voltage, or a signal from a thermocouple, resistance thermometer, remote sensor or potentiometer – to a proportional analogue output signal.

The analogue output signal is either an impressed current or superimposed voltage which is processed by other devices for purposes of displaying, recording and/or regulating a constant.

A considerable number of measuring ranges including bipolar or spread ranges are available.

Input variable and measuring range are programmed with the aid of a PC and the corresponding software. Other parameters relating to specific input variable data, the analogue output signal, the transmission mode, the operating sense and the open-circuit sensor supervision can also be programmed.

The open-circuit sensor supervision is in operation when the V 604 is used in conjunction with a thermocouple, resistance thermometer, remote sensor or potentiometer.

The transmitter fulfils all the important requirements and regulations concerning electromagnetic compatibility EMC and Safety (IEC 1010 resp. EN 61 010). It was developed and is manufactured and tested in strict accordance with the quality assurance standard ISO 9001.

Production QA is also certified according to guideline 94/9/EG.

Features

- **Input variable** (temperature, variation of resistance, DC signal) **and measuring range programmed using PC / Simplifies project planning** and engineering (the final measuring range can be determined during commissioning). **Short delivery times and low stocking levels**
- **Analogue output signal also programmed on the PC** (impressed current or superimposed voltage for all ranges between – 20 and + 20 mA DC resp. – 12 and + 15 V DC) / **Universally applicable. Short delivery times and low stocking levels**
- **Electric insulation between measured variable, analogue output signal and power supply / Safe isolation acc. to EN 61 010**
- **Wide power supply tolerance / Only two operating voltage ranges between 20 and a maximum of 264 V DC/AC**
- Standard Version as per Germanischer Lloyd
- **Provision for either snapping the transmitter onto top-hat rails or securing it with screws to a wall or panel**
- **Housing only 17.5 mm wide** (size S17 housing)/ **Low space requirement**
- **Other programmable parameters: specific measured variable data** (e.g. two, three or four-wire connection for resistance thermometers, "internal" or "external" cold junction compensation of thermocouples etc,) **transmission mode** (special linearised characteristic or characteristic determined by a mathematical relationship, e.g. output signal = f (measured variable)), **operating sense** (output signal directly or inversely proportional to the measured variable) **and open-circuit sensor supervision** (output signal assumes fixed preset value between – 10 and 110%, supplementary output contact signalling relay) / **Highly flexible solutions for measurement problems**
- **All programming operations by IBM XT, AT or compatible PC running the self-explanatory, menu-controlled programming software, if necessary, during operation / No ancillary hand-held terminals needed**
- **Digital measured variable data available at the programming interface/ Simplifies commissioning, measured variable and signals can be viewed on PC in the field**
- **Standard software includes functional test program / No external simulator or signal injection necessary**
- **Self-monitoring function and continuously running test program /Automatic signalling of defects and device failure**

Principle of operation (Fig. 3)

The measured variable M is stepped down to a voltage between –300 and 300 mV in the input stage (1). The input stage includes potential dividers and shunts for this purpose. A constant reference current facilitates the measurement of resistance. Depending on the type of measurement, either one or more of the terminals 1, 2, 6, 7 and 12 and the common ground terminal 11 are used.

The constant reference current which is needed to convert a variation of resistance such as that of a resistance thermometer, remote sensor or potentiometer to a voltage signal is available at terminal 6. The internal current source (2) automatically sets the reference current to either 60 or 380 A to suit the measuring range. The corresponding signal is applied to terminal 1 and is used for resistance measurement.

Terminal 2 is used for "active" sensors, i.e. thermocouples or other mV generators which inject a voltage between –300 and 300 mV. Small currents from the open-circuit sensor supervision (3) are superimposed on the signals at terminals 1 and 2 in order to monitor the continuity of the measurement circuit. Terminal 2 is also connected to the cold junction compensation element which is a Ni 100 resistor built into the terminal block.

Terminals 7 and 12 are also input terminals and are used for measuring currents and for voltages which exceed 300 mV.

An extremely important component of the input stage is the EMC filter which protects the transmitter from interference or even destruction due to induced electromagnetic waves.

From the input stage, the measured variable (e.g. the voltage of a thermocouple) and the two auxiliary signals (cold junction compensation and the open-circuit sensor supervision) go to the multiplexer (4), which controlled by the micro-controller (6) applies them cyclically to the A/D converter (5).

The A/D converter operates according to the dual slope principle with an integration time of 20 ms at 50 Hz and a conversion time of approximately 38 ms per cycle. The internal resolution is 12 Bit regardless of measuring range.

The micro-controller relates the measured variable to the auxiliary signals and to the data which were loaded in the micro-controller's EEPROM via the programming connector (7) when the transmitter was configured. These settings determine the type of measured variable, the measuring range, the transmission mode (e.g. linearised temperature/thermocouple voltage relationship) and the operating sense (output signal directly or inversely proportional to the measured variable). The measured signal is then filtered again, but this time digitally to achieve the maximum possible immunity to interference. Finally the value of the measured variable for the output signal is computed. Apart from normal operation, the programming connector is also used to transfer measured variables on-line from the transmitter to the PC or vice versa. This is especially useful during commissioning and maintenance.

Depending on the measured variable and the input circuit, it can take 0.4 to 1.1 seconds before a valid signal arrives at the optocoupler (8). The different processing times result from the fact that, for example, a temperature measurement with a four-wire resistance thermometer and open-circuit sensor supervision requires more measuring cycles than the straight forward measurement of a low voltage.

The main purpose of the opto-coupler is to provide electrical insulation between input and output. On the output side of the optocoupler, the D/A converter (9) transforms the digital signal back to an analogue signal which is then amplified in the output stage (10) and split into two non-electrically isolated output channels. A powerful heavy-duty output is available at A1 and a less powerful output for a field display unit at A2. By a combination of programming and setting the 8 DIP switches in the output stage, the signals at A1 and A2 can be configured to be either a DC current or DC voltage (but both must be either one or the other). The signal A1 is available at terminals 9 and 4 and A2 at terminals 8 and 3.

If the micro-controller (6) detects an open-circuit measurement sensor, it firstly sets the two output signals A1 and A2 to a

constant value. The latter can be programmed to adopt a preset value between -10 and 110% or to maintain the value it had at the instant the open-circuit was detected. In this state, the micro-controller also switches on the red LED (11) and causes the green LED (12) to flash. Via the opto-coupler (8), it also excites the relay driver (13) which depending on configuration switches the relay (14) to its energised or de-energised state. The output contact is available at terminals 13, 14 and 15. It is used by safety circuits. In addition to being able to program the relay to be either energised or de-energised, it can also be set to "relay disabled". In this case, an open circuit sensor is only signalled by the output signal being held constant, the red LED being switched on and the green LED flashing. The relay can also be configured to monitor the measured variable in relation to a programmable limit.

The normal state of the transmitter is signalled when the green LED (12) is continuously lit. As explained above, it flashes should the measurement sensor become open-circuit. It also flashes, however, if the measured variable falls 10% below the start of the measuring range or rises 10% above its maximum value and during the first five seconds after the transmitter is switched on.

The push-button S1 is for automatically calibrating the leads of a two-wire resistance thermometer circuit. This is done by temporarily shorting the resistance sensor and pressing the button for at least three seconds. The lead resistance is then automatically measured and taken into account when evaluating the measure variable.

The power supply H is connected to terminals 5 and 10 on the input block (15). The polarity is of no consequence, because the input voltage is chopped on the primary side of the power block (16) before being applied to a full-wave rectifier. Apart from the terminals, the input block (15) also contains an EMC filter which suppresses any electromagnetic interference superimposed on the power supply. The transformer block (17) provides the electrical insulation between the power supply and the other circuits and also derives two secondary voltages. One of these (5 V) is rectified and stabilised in (18) and then supplies the electronic circuits on the input side of the transmitter. The other AC from block (17) (-16 V / + 18 V) is rectified in (19) and used to supply the relay driver and the other components on the output side of the transmitter.

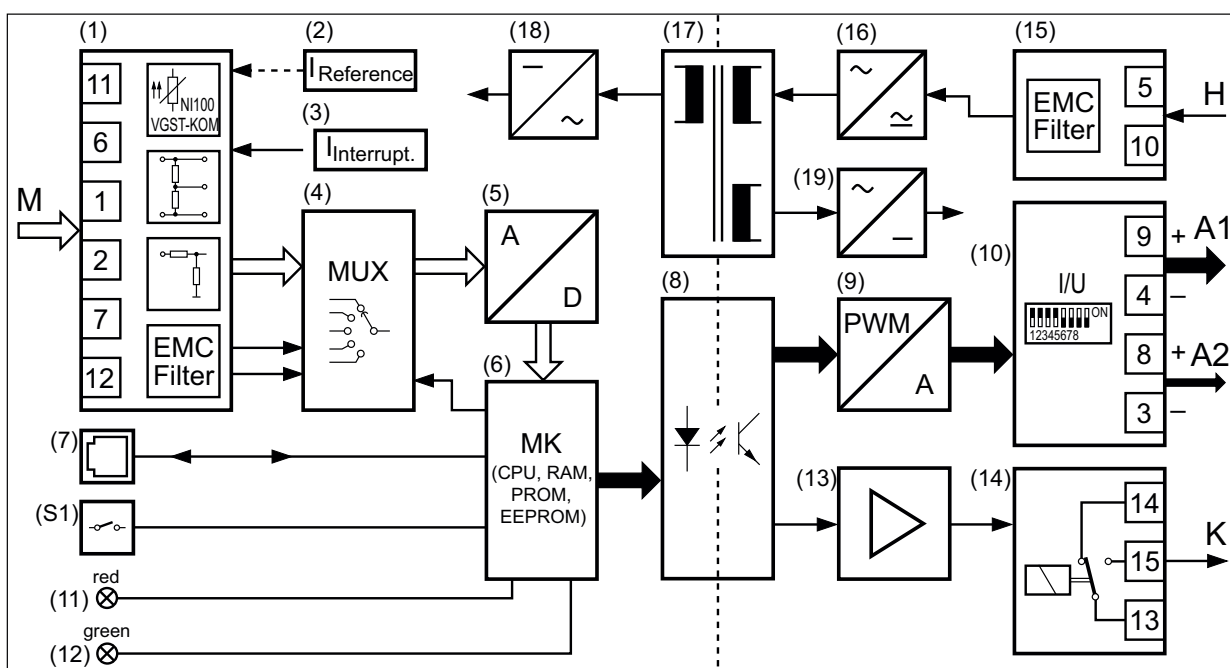

Fig. 3. Block diagram. I

Technical data

Measuring input

Measured variable M

The measured variable M and the measuring range can be programmed

Table 1: Measured variables and measuring ranges

Measured variables	Measuring ranges		
	Limits	Min. span	Max. span
DC voltages			
direct input	±300 mV ¹	2 mV	300 mV
via potential divider ²	± 40 V ¹	300 mV	40 V
DC currents			
low current range	± 12 mA ¹	0.08 mA	12 mA
high current range	-50 to + 100 mA ¹	0.75 mA	100 mA

Measured variables	Measuring ranges		
T temperature monitored by two, three or four-wire resistance thermometers	-200 to 850 °C		
	low resistance range	0...740 ¹	8 740
	high resistance range	0...5000 ¹	40 5000
Temperature monitored by thermocouples	-270 to 1820 °C	2 mV	300 mV
Variation of resistance of remote sensors / potentiometers			
	low resistance range	0...740 ¹	8 740
	high resistance range	0...5000 ¹	40 5000

¹ Note permissible value of the ratio "full-scale value/span < 20".

Programmable universal transmitter

Table 8: Temperature measuring ranges

Measuring range [°C]	Resistance thermometer		Thermocouple									
	Pt100	Ni100	B	E	J	K	L	N	R	S	T	U
0... 20												
0... 25	X	X										
0... 40	X	X		X	X		X					
0... 50	X	X		X	X	X	X				X	X
0... 60	X	X		X	X	X	X				X	X
0... 80	X	X		X	X	X	X				X	X
0... 100	X	X		X	X	X	X	X			X	X
0... 120	X	X		X	X	X	X	X			X	X
0... 150	X	X		X	X	X	X	X			X	X
0... 200	X	X		X	X	X	X	X			X	X
0... 250	X	X		X	X	X	X	X			X	X
0... 300	X			X	X	X	X	X	X	X	X	X
0... 400	X			X	X	X	X	X	X	X	X	X
0... 500	X			X	X	X	X	X	X	X		X
0... 600	X			X	X	X	X	X	X	X		X
0... 800			X									
0... 900			X	X	X	X	X	X	X	X		
0... 1000			X	X	X	X		X	X	X		
0... 1200			X		X	X		X	X	X		
0... 1500			X						X	X		
0... 1600			X						X	X		
50... 150	X	X		X	X	X	X	X			X	X
100... 300	X			X	X	X	X	X			X	X
300... 600	X			X	X	X	X	X	X	X		X
600... 900			X	X	X	X	X	X	X	X		
600... 1000			X	X	X	X		X	X	X		
900... 1200			X		X	X		X	X	X		
600... 1600			X						X	X		
600... 1800			X									
-20... 20	X	X		X	X		X					
-10... 40	X	X		X	X	X	X					X
-30... 60	X	X		X	X	X	X	X			X	X
Measuring range limits [°C]	-200 to 850	-60 to 250	0 to 1820	-270 to 1000	-210 to 1200	-270 to 1372	-200 to 900	-270 to 1300	-50 to 1769	-50 to 1769	-270 to 400	-200 to 600
	ΔR min 8 at full-scale ≤ 740 ΔR min 40 at full-scale > 740 to 5000		ΔU min 2 mV									

DC voltage

Measuring range See Table 1
Direct input Wiring diagram No. 1¹
Input resistance $R_i > 10 \text{ M}\Omega$

Continuous overload
max. $-1.5 \text{ V}, +5 \text{ V}$

Input via potential divider Wiring diagram No. 2¹
Input resistance $R_i = 1 \text{ M}\Omega$
Continuous overload
max. $\pm 100 \text{ V}$

DC current

Measuring range See Table 1
Low currents Wiring diagram No. 3¹
Input resistance $R_i = 24.7 \Omega$

Continuous overload
max. 150 mA

High currents Wiring diagram No. 3¹
Input resistance $R_i = 24.7 \Omega$
Continuous overload
max. 150 mA

Resistance thermometer

Measuring range See Tables 1 and 8
Resistance types Type Pt 100 (DIN IEC 751)
Type Ni 100 (DIN 43 760)
Type Pt 20/20°C
Type Cu 10/25°C
Type Cu 20/25°C
See "Table 6: Specification and ordering information", feature 6 for other Pt or Ni.

Measuring current $\leq 0.38 \text{ mA}$ for
measuring ranges 0...740 Ω
or
 $\leq 0.06 \text{ mA}$ for
measuring ranges 0...5000 Ω

Standard circuit 1 resistance thermometer:
– two-wire connection,
wiring diagram No. 4¹
– three-wire connection,
wiring diagram No. 5¹
– four-wire connection,
wiring diagram No. 6¹

Summation circuit Series or parallel connection of 2 or
more two, three or four-wire
resistance thermometers for
deriving the mean temperature or
for matching other types of sensors,
wiring diagram Nos. 4 - 6¹

Differential circuit 2 identical three-wire resistance
thermometers for deriving the mean
temperature RT1-RT2,
wiring diagram No. 7¹

Input resistance $R_i > 10 \text{ M}\Omega$
Lead resistance $\leq 30 \Omega$ per lead

Thermocouples

Measuring range See Tables 1 and 8
Thermocouple pairs Type B: Pt30Rh-Pt6Rh (IEC 584)
Type E: NiCr-CuNi (IEC 584)
Type J: Fe-CuNi (IEC 584)
Type K: NiCr-Ni (IEC 584)
Type L: Fe-CuNi (DIN 43710)
Type N: NiCrSi-NiSi (IEC 584)
Type R: Pt13Rh-Pt (IEC 584)
Type S: Pt10Rh-Pt (IEC 584)
Type T: Cu-CuNi (IEC 584)
Type U: Cu-CuNi (DIN 43710)
Type W5-W26 Re
Other thermocouple pairs on
request

Standard circuit 1 thermocouple, internal cold
junction compensation,
wiring diagram No. 8¹
1 thermocouple, external cold
junction compensation,
wiring diagram No. 9¹

Summation circuit 2 or more thermocouples in a
summation circuit for deriving the
mean temperature, external cold
junction compensation,
wiring diagram No. 10¹

Differential circuit 2 identical thermocouples in a
differential circuit for deriving the
mean temperature TC1 – TC2, no
provision for cold junction
compensation,
wiring diagram No. 11¹

Input resistance $R_i > 10 \text{ M}\Omega$

Cold junction

compensation Internal or external
Internal Incorporated Ni 100
Permissible variation
of the internal cold
junction compensation $\pm 0.5 \text{ K}$ at 23°C, + 0.25 K/10 K
External 0...70°C, programmable

¹ See "Table 7: Measuring input".

Resistance sensor, potentiometer

Measuring range See Table 1
Resistance sensor
types Type WF
Type WF DIN
Potentiometer see "Table 6:
Specification and ordering
information" feature 5.

Measuring current $\leq 0.38 \text{ mA}$ for
measuring range 0...740 Ω
or
 $\leq 0.06 \text{ mA}$ for
measuring range 0...5000 Ω

Kinds of input 1 resistance sensor WF
current measured at pick-up,
wiring diagram No. 12¹
1 resistance sensor WF DIN
current measured at pick-up,
wiring diagram No. 13¹
1 resistance sensor for two, three or
four-wire connection,
wiring diagram No. 4-6¹
2 identical three-wire resistance
sensors for deriving a differential,
wiring diagram No. 7¹

Input resistance $R_i > 10 \text{ M}\Omega$
Lead resistance $\leq 30 \Omega$ per lead

Output signal $\ominus \rightarrow$ **Output signals A1 and A2**

The output signals available at A1 and A2 can be configured for either an impressed DC current I_A or a superimposed DC voltage U_A by appropriately setting DIP switches. The desired range is programmed using a PC. A1 and A2 are not DC isolated and exhibit the same value.

Standard ranges for I A 0...20 mA or 4...20 mA
Non-standard ranges Limits -22 to $+22 \text{ mA}$

Min. span 5 mA
Max. span 40 mA
Open-circuit voltage Neg. -13.2 ... -18 V , pos. 16.5...21 V
Burden voltage I_{A1} + 15 V, resp. -12 V
External resistance I_{A1} Rext max. $[k] = \frac{15 \text{ V}}{I_{AN} [\text{mA}]}$
 I_{AN} = full-scale output current

< 0.3 V
 resp. = $\frac{-12 V}{I_{AN} [mA]}$
 I_{AN} = full-scale output current
 < 0.3 V

Burden voltage I_{A2}

¹ See "Table 7: Measuring input".

² In relation to analogue output span A1 resp. A2.

External resistance I_{A2} : $0.3 V$

Residual ripple
 Rext max. [kΩ] = $I_{AN} [mA]$
 < 1% p.p., DC ... 10 kHz
 < 1.5% p.p. for an output span
 < 10 mA

Standard ranges for U
 Non-standard ranges
 A 0...5, 1...5, 0...10 or 2...10 V
 Limits -12 to + 15 V
 Min. span 4 V
 Max. span 27 V

Open-circuit voltage ≤ 40 mA

Load capacity U_{A1} / U_{A2}

External resistance

U_{A1} / U_{A2}
 $R_{ext} [k\Omega] \geq \frac{U_A [V]}{20 mA}$

Residual ripple
 < 1% p.p., DC ... 10 kHz
 < 1.5% p.p. for an output span < 8 V

Fixed settings for the output signals A1 and A2

After switching on
 A1 and A2 are at a fixed value for 5 s after switching on (default).
 Setting range -10 to 110%² programmable, e.g. between 2.4 and 21.6 mA (for a scale of 4 to 20 mA).
 The green LED ON flashes for the 5 s

When input variable out of limits
 A1 and A2 are at either a lower or an upper fixed value when the input variable...
 ... falls more than 10% below the minimum value of the permissible range
 ... exceeds the maximum value of the permissible range by more than 10%.
 Lower fixed value = -10%², e.g. -2 mA (for a scale of 0 to 20 mA).
 Upper fixed value = 110%², e.g. 22 mA (for a scale of 0 to 20 mA).
 The green LED ON flashes
 Open-circuit sensor: A1 and A2 are at a fixed value when an open-circuit sensor is detected (see Section "Sensor and open-circuit lead supervision").
 The fixed value of A1 and A2 is configured to either maintain their values at the instant the open-circuit occurs or adopt a preset value between -10 and 110%², e.g. between 1.2 and 10.8 V (for a scale of 2 to 10 V).
 The green LED ON flashes and the red LED \rightarrow lights continuously

Programmable universal transmitter

Output characteristic

Characteristic: Programmable

Table 2: Available characteristics (acc. to measured variable)

Measured variables	Characteristic	
DC voltage		
DC current		
Resistance thermometer (linear variation of resistance)		
Thermocouple (linear variation of voltage)		
Sensor or potentiometer	A = M	
DC voltage		
DC current		$A = \sqrt{M}$ or $A = \sqrt[3]{M}$
DC voltage		Special characteristics
DC current		
Resistance thermometer (linear variation with temperature)		
Thermocouple signal (linear variation with temperature)		
Sensor or potentiometer	$A = f(M)^1$ linearised	
DC voltage		Special characteristics
DC current		
Sensor or potentiometer		

Operating sense: Programmable output signal directly or inversely proportional to measured variable

Setting time (IEC 770): Programmable from 2 to 30 s

¹25 input points M given referred to a linear output scale from -10% to + 110% in steps of 5%.

Open-circuit sensor circuit supervision

Potentiometer input circuits are supervised. The circuits of DC voltage resistance thermometers, thermocouples, remote sensors and current inputs are not supervised.

Pick-up/reset level 1 to 15 kΩ acc. to kind of measurement and range

Signalling modes

Output signals A1 and A2	Programmable fixed values. The fixed value of A1 and A2 is configured to either maintain their values at the instant the open-circuit occurs or adopt a preset value between - 10 and 110% ² , e.g. between 1.2 and 10.8 V (for a scale of 2 to 10 V)
Front plate signals	The green LED ON flashes and the red LED \rightarrow lights continuously
Output contact K	Relay 1 potentially-free changeover contact (see Table 4) Operating sense programmable The relay can be either energised or de-energised in the case of a disturbance. Set to "Relay inactive" if not required!

² 25 input points M given referred to a quadratic output scale from -10% to + 110%. Pre-defined output points: 0, 0, 0, 0.25, 1, 2.25, 4.00, 6.25, 9.00, 12.25, 16.00, 20.25, 25.00, 30.25, 36.00, 42.25, 49.00, 56.25, 64.00, 72.25, 81.00, 90.25, 100.0, 110.0, 110.0%.

³ An external supply fuse must be provided for DC supply voltages > 125 V.

⁴ In relation to analogue output span A1 resp. A2.

Supervising a limit GW (□)

This Section only applies to transmitters which are not configured to use the output contact K in conjunction with the open-circuit sensor supervision (see Section "Open-circuit sensor circuit supervision \rightarrow ").

This applies ...

... in all cases when the measured variable is a DC voltage or current

... when the measured variable is a resistance thermometer, a thermocouple, a remote sensor or a potentiometer and the relay is set to "Relay disabled"

Limit:	Programmable - Disabled - Lower limit value of the measured variable (see Fig. 6, left) - Upper limit value of the measured variable (see Fig. 6, left) - Maximum rate of change of the measured variable
--------	---

$$\text{Slope} = \frac{\Delta \text{measured variable}}{\Delta t}$$

(see Fig. 6, right)

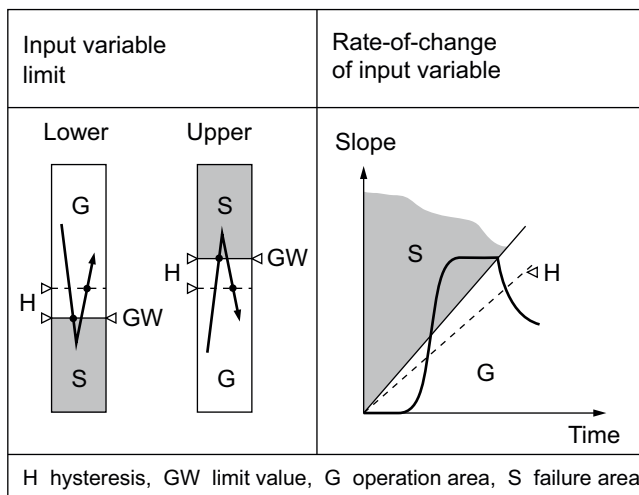

Fig6. Switching function according to limit monitored

Trip point setting

using PC for GW	Programmable - between -10 and 110% ¹ (of the measured variable) - between + 1 and + 50% \dot{s} (of the rate-of-change of the measured variable)
Reset ratio	Programmable - between 0.5 and 100% ¹ (of the measured variable) - between 1 and 100% \dot{s} (of the rate-of-change of the measured variable)
Operating and resetting delays	Programmable - between 1 to 60 s
Operating sense	Programmable - Relay energized, LED on - Relay energized, LED off - Relay de-energized, LED on - Relay de-energized, LED off (once limit reached)
Relay status signal	GW by red LED (□)

Table 4: Contact arrangement and data

Symbol	Material	Contactrating
	Gold flashed silveralloy	AC: $\leq 2A / 250 V$ (500 VA) DC: $\leq 1A / 0.1 \dots 250 V$ (30 W)

Relay approved by UL, CSA, TÜV, SEV

Accuracy data (acc. to DIN/IEC 770)

Basic accuracy	Max. error $< \pm 0.2\%$ Including linearity and repeatability errors for current, voltage and resistance measurement
----------------	--

Reference conditions

Ambient temperature	23 ⁰ C, $\pm 2 K$
Power supply	24 V DC $\pm 10\%$ and 230 V AC $\pm 10\%$
Output burden	Current: $0.5 \cdot R_{ext} \text{ max.}$ Voltage: $2 \cdot R_{ext} \text{ min.}$

Influencing factors

Temperature	$< \pm 0.1 \dots 0.15\%$ per 10 K
Burden	$< \pm 0.1\%$ for current output $< 0.2\%$ for voltage output, providing $R_{ext} > 2 R_{ext} \text{ min.}$
Long-time drift	$< \pm 0.3\%$ / 12 months
Switch-on drift	$< \pm 0.5\%$
Common and transverse mode influence	$< \pm 0.2\%$
+ or - output connected to ground	$< \pm 0.2\%$

Additional error (additive)

$< \pm 0.3\%$ for linearised characteristic
$< \pm 0.3\%$ for measuring ranges
$< 5 \text{ mV}, 0.3 \dots 0.75 \text{ V},$
$< 0.2 \text{ mA}$ or $< 20 \text{ V}$
$< \pm 0.3\%$ for a high ratio between full-scale value and measuring range $>$ factor 10, e.g. Pt 100
175.84 ... 194.07 Ω
200 0C ... 250 ⁰ C
$< \pm 0.3\%$ for current output
$< 10 \text{ mA}$ span

< ± 0.3% for voltage output
< 8 V span
< 2 · (basic and additional error)
for two-wire resistance
measurement

Power supply H →○

DC, AC power pack (DC and 45...400 Hz)
Table 3: Nominal voltage and tolerance

Nominal voltage U_N	Tolerance
24... 60 V DC / AC	DC -15...+ 33%
85...230 V ³ DC / AC	AC ± 15%

Power consumption < 1.4 W resp. < 2.7 VA

Ambient conditions

Commissioning temperature - 10 to + 55°C
Operating temperature - 25 to + 55°C, Ex - 20 to + 55°C
Storage temperature - 40 to + 70°C
Relative humidity annual mean ≤ 75% standard climatic rating
≤ 95% enhanced climatic rating

Programming connector

Interface RS 232 C
FCC-68 socket 6/6 pin
Signal level TTL (0/5 V)
Power consumption Approx. 50 mW

Standards

Electromagnetic compatibility

The standards DIN EN 50 081-2 and & DIN EN 50 082-2 are observed
Acc. to DIN EN 50 020: 1996-04

Intrinsically safe Protection (acc. to IEC 529 resp. EN 60 529)

Housing IP 40
Terminals IP 20
Acc. to IEC 1010 resp. EN 61 010
Measuring input < 40 V
Programming connector, measuring outputs < 25 V
Output contact, power supply < 250 V

Electrical design Operating voltages

Measuring input, programming connector, measuring outputs, output contact, power supply < 250 V

Rated insulation voltages

2
Measuring input, programming connector, measuring outputs, output contact

Pollution degree Installation category II

Power supply
Measuring input and programming connector to:
- Measuring outputs 2.3 kV, 50 Hz, 1 min.
- Power supply 3.7 kV, 50 Hz, 1 min.
- Output contact 2.3 kV, 50 Hz, 1 min.

Installation category III Test voltages

Measuring outputs to:
- Power supply 3.7 kV, 50 Hz, 1 min.
- Output contact 2.3 kV, 50 Hz, 1 min.
Serial interface for the PC to:
- everything else 4 kV, 50 Hz, 1 min. (PRKAB 600)

Installation data

Housing Housing type S17
Refer to Section "Dimensional drawings" for dimensions

Material of housing Lexan 940 (polycarbonate).
Flammability Class V-0 acc. to UL 94, self-extinguishing, non-dripping, free of halogen

Mounting For snapping onto top-hat rail (35 x 15 mm or 35 x 7.5 mm) acc. to EN 50 022
or
directly onto a wall or panel using the pull-out screw hole brackets

Mounting position Any

Terminals DIN/VDE 0609
Screw terminals with wire guards for light PVC wiring and max. 2 x 0.75 mm² or 1 x 2.5 mm²

Permissible vibrations 2 g acc. to EN 60 068-2-6
10 ... 150 ... 10 Hz
10 cycles

Choc 3 x 50 g
3 shocks each in 6 directions acc. to EN 60 068-2-27

Weight Approx. 0.25 kg

Electrical insulation All circuits (measuring input/measuring outputs/power supply/output contact) are electrically insulated.
Programming connector and measuring input are connected.
The PC is electrically insulated by the programming cable PRKAB 600.

Programming (Figs. 4 and 5)

A PC with RS 232 C interface (Windows 3.1x, 95, 98, NT or 2000), the programming cable PRKAB 600 and the configuration software VC 600 are required to program the transmitter. (Details of the programming cable and the software are to be found in the separate Data sheet: PRKAB 600 Le.)

The connections between

"PC ↔ PRKAB 600 ↔ V 604" can be seen from Fig. 4. The power supply must be applied to V 604 before it can be programmed.

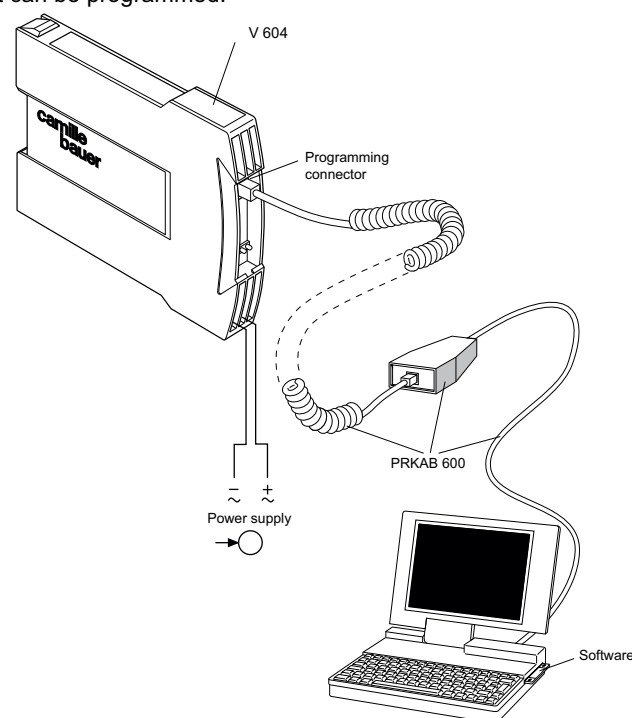

Fig. 4

The software VC 600 is supplied on a CD.

The programming cable PRKAB 600 adjusts the signal level and provides the electrical insulation between the PC and V 604.

The programming cable PRKAB 600 is used for programming both standard and Ex versions.

Of the programmable details listed in section "Features / Benefits" one parameter – the output signal – has to be determined by PC programming as well as mechanical setting on the transmitter unit ...

... the output signal range by PC

... the type of output (current or voltage signal) has to be set by DIP switch (see Fig. 5).

The eight pole DIP switch is located on the PCB in the V 604.

DIP switches	Type of output signal
	load-independent current
	load-independent voltage

Fig. 5

Electrical Connections

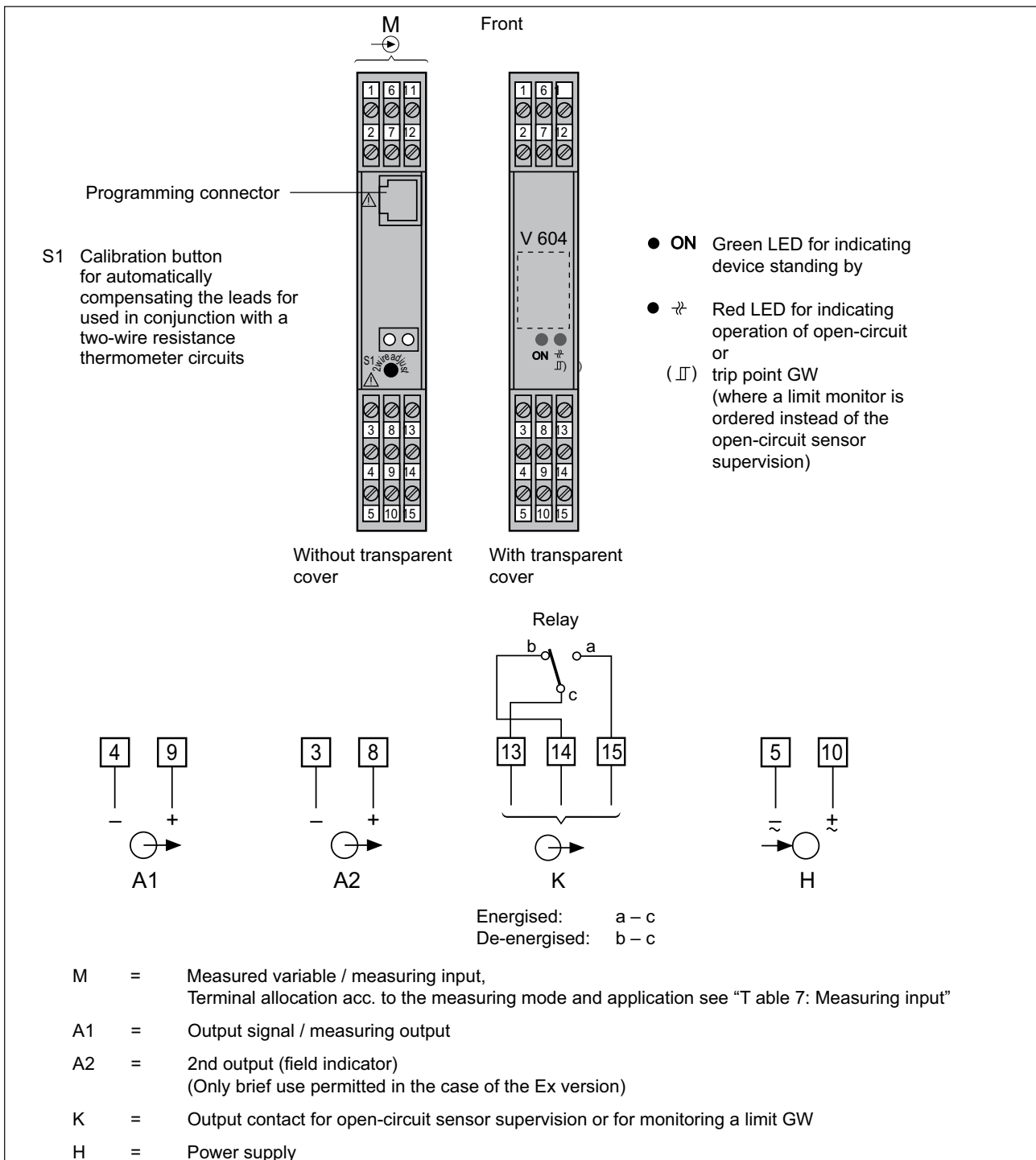
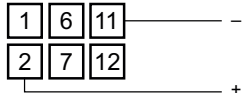
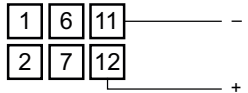
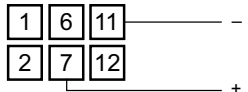
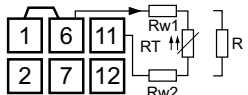
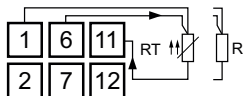
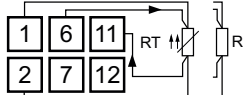
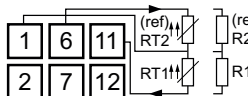
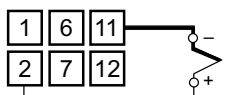
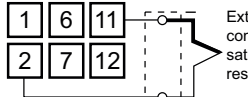
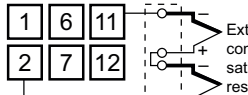
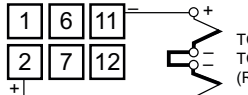
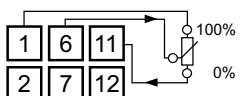
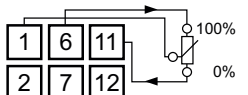

Table7: Measuring Input

Measurement	Measuring range limits	Measuring span	Wiring diagram	
			No.	Terminal arrangement
DC voltage (direct input)	- 300...0...300 mV	2...300 mV	1	
DC voltage (input via potential divider)	- 40...0...40 V	0.3...40 V	2	
DC current	- 12...0... 12 mA/ - 50...0...100 mA	0.08... 12 mA/ 0.75...100 mA	3	
Resistance thermometer RT or resistance measurement R, two-wire connection	0... 740 Ω / 0...5000 Ω	8... 740 Ω / 40...5000 Ω	4	
Resistance thermometer RT or resistance measurement R, three-wire connection	0... 740 Ω / 0...5000 Ω	8... 740 Ω / 40...5000 Ω	5	
Resistance thermometer RT or resistance measurement R, four-wire connection	0... 740 Ω / 0...5000 Ω	8... 740 Ω / 40...5000 Ω	6	
2 identical three-wire resistance transmitters RT for deriving the difference	RT1 - Rt2 0... 740 Ω / 0...5000 Ω	8... 740 Ω / 40...5000 Ω	7	
Thermocouple TC Cold junction compensation internal	- 300...0...300 mV	2...300 mV	8	
Thermocouple TC Cold junction compensation external	- 300...0...300 mV	2...300 mV	9	
Thermocouple TC in a summation circuit for deriving the mean temperature	- 300...0...300 mV	2...300 mV	10	
Thermocouple TC in a differential circuit for deriving the mean temperature	TC1 - TC2 - 300...0...300 mV	2...300 mV	11	
Resistance sensor WF	0... 740 Ω / 0...5000 Ω	8... 740 Ω / 40...5000 Ω	12	
Resistance sensor WF DIN	0... 740 Ω / 0...5000 Ω	8... 740 Ω / 40...5000 Ω	13	

Basic configuration

The transmitter V 604 is also available already programmed with a basic configuration which is especially recommended in cases where the programming data is not known at the time of ordering (see "Table 6: Specification and ordering information" Feature 4.).

V 604 supplied as standard versions are programmed for basic configuration (see "Table 5: Standard versions").

Basic configuration: Measuring input 0...5 V DC
 Measuring output 0...20 mA linear,
 fixed value 0%
 during 5 s after switching on
 Setting time 0.7 s
 Open-circuit supervision inactive
 Mains ripple suppression 50 Hz
 Limit functions inactive

Table 5: Standard versions

The following 8 transmitter versions are already programmed for basic configuration and are available as standard versions. It is necessary to quote the Order No.:

Cold junction compensation	Climatic rating	Instrument	Power supply
Included	standard	Standard version	24... 60 V DC / AC
			85...230 V DC / AC

The complete Order Code 1 604-...0 and/or a description should be stated for other versions with the basic works configuration.

¹ See "Table 6: Specification and ordering information".

Table 6: Specification and ordering information(see also "Table 5: Standard versions")

Order Code 604 -			
Features, Selection	*SCODE	no-go	
1.Mechanical design 1) Housing S17			↑ ↑ ↑ ↑ ↑ ↑ ↑ ↑ ↑ Insert code in the 1st box on page 13! 1
2.Version / Power supply H (nominal voltage U_N) 1) Standard / 24... 60V DC/AC 2) Standard / 85...230V DC/AC			. 1 2
3.Climatic rating / Cold junction compensation 2) Standard climatic rating; instrument with cold junction compensation			. . 2
4.Configuration 0) Basicconfiguration,programmed 1) Programmed to order 2) Programmedtoorderwithtestcertificate Line 0: If you wish to order the basic configuration, the line "0)" must be selected for options 4. to 13., i.e. all the digits of the order code after the 4th, are zeros, see "Table 5: Standard versions" Lines 0 and 1: No test certificate	Z		. . . 0 1 2
5.Measured variable / Measuring input M DC voltage 0) 0... 5Vlinear 1) 1... 5Vlinear 2) 0...10Vlinear 3) 2...10Vlinear 4) Linearinput,otherranges [V] 5) Squarerootinputfunction [V] 6) Inputx3/2 [V] Lines 4 to 6: DC [V] 0...0.002 to 0... ≤ 40 V (Ex max. 30 V) or span 0.002 to 40 V between - 40 and 40 V, ratio full-scale/span ≤ 20	C C C C C C	Z Z Z Z 0 1 2 3 4 5 6

Feature "5. Measured variable / Measuring input M" continued on next page!

© Ziegler Instruments Order No. V604 Data sheet-EL-R0-920828-47-2013-EN

Order Code 604 -									
Features, Selection			*SCODE		no-go				
5. Measured variable / Measuring input M (continuation)									
DC current									
7) 0...20mA linear						C	Z	7
8) 4...20mA linear						C	Z	8
9) Linear input, other ranges [mA]						C	Z	9
A) Square root input function [mA]						C	Z	A
B) Input x 3/2 [mA]						C	Z	B
Lines 9, A and B: DC [mA] 0...0.08 to 0...100 mA or span 0.08 to 100 mA between -50 and 100 mA, ratio full-scale/span ≤ 20									
Resistance thermometer, linearised									
C) Two-wire connection, R_L [Ω]						E	Z	C
D) Three-wire connection, $R_L \leq 30$ /wire						E	Z	D
E) Four-wire connection, $R_L \leq 30$ /wire						E	Z	E
Resistance thermometer, non-linearised									
F) Two-wire connection, R_L [Ω]						E	Z	F
G) Three-wire connection, $R_L \leq 30$ /wire						E	Z	G
H) Four-wire connection, $R_L \leq 30$ /wire						E	Z	H
J) Temperature difference [deg] 2 identical resistance thermometers in three-wire connection						E	Z	J
Lines C and F: Specify total lead resistance R_L [], any value between 0 and 60 . This may be omitted, because two leads can be compensated automatically on site Line J: Temperature difference; specify measuring range [deg], also for feature 6.: t_{min} ; t_{max} ; $t_{reference}$									
Thermocouple linearised									
K) Internal cold junction compensation (not for type B)						DT	Z	K
L) External cold junction compensation (specify 0°C for type B)* t_K [°C]						D	Z	L
Thermocouple non-linearised									
M) Internal cold junction compensation (not for type B)						DT	Z	M
N) External cold junction compensation (specify 0°C for type B)* t_K [°C]						D	Z	N
P) Average temperature [n] t_K [°C]						D	Z	P
Q) Temperature difference [deg] 2 identical thermocouples						D	Z	Q
Lines L, N and P: Specify external cold junction temperature t_K [°C], any value between 0 and 70°C Line P: State number of sensors [n] Line Q: Temperature difference; specify measuring range [deg], also for feature 6.: t_{min} ; t_{max} ; $t_{reference}$									

Insert code in the 1st box of the next page!

* Because of its characteristic, thermocouple type B does not require compensating leads nor cold junction compensation.
Feature "5. Measured variable / Measuring input M" continued on next page!

© Ziegler Instruments Order No. V604 Data sheet-EL.R0-920828-47-2013-EN

Order Code 604 -							
Features, Selection				*SCODE	no-go		
5.Measured variable / Measuring input M (continuation)							
Resistance transmitter / Potentiometer							
R) WF	Measuring range [Ω]		F	Z	R		
$R_L \leq 30 \Omega / \text{wire}$							
S) WF DIN	Measuring range [Ω]		F	Z	S		
$R_L \leq 30 \Omega / \text{wire}$							
T) Potentiometer	Measuring range [Ω]		F	Z	T		
Two-wire connection		and R_L [Ω]					
U) Potentiometer	Measuring range [Ω]		F	Z	U		
Three-wire connection							
$R_L \leq 30 \Omega / \text{wire}$							
V) Potentiometer	Measuring range [Ω]		F	Z	V		
Four-wire connection							
$R_L \leq 30 \Omega / \text{wire}$							
<p>Lines R to V: Specify initial resistance, span and residual resistance in ; example: 200...600...200; 0...500...0; 10...80...20 Minimum span at full-scale value ME: 8 Ω for ME ≤ 740 Ω 40 Ω for ME > 740 Ω. Max. resistance value (initial value + span + lead resistance) 5000Ω. Note: Initial measuring range < 10 x span Line T : Specify total lead resistance R_L [Ω], any value between 0 and 60 Ω. This may be omitted, because two leads can be compensated automatically on site</p>							
Special characteristic							
Z) For special	[V] [mA] [Ω]			Z	Z		
characteristic							
Fill in T able W 2357 e for special characteristic for V, mA or Ω input.							
6.Sensor type / Temperature range							
0) No temperature measurement							. 0
1) Pt 100	[°C]			CDFZ	. 1		
2) Ni 100	[°C]			CDFZ	. 2		
3) Other Pt [Ω]	[°C]			CDFZ	. 3		
4) Other Ni [Ω]	[°C]			CDFZ	. 4		
5) Pt 20 / 20 °C	[°C]			CDFZ	. 5		
6) Cu 10 / 25 °C	[°C]			CDFZ	. 6		
<p>Lines 1 to 6: Specify measuring range in [°C] or °F, refer to Table 8 for the operating limits for each type of sensors. For temperature difference measurement: specify measuring range and reference temperature for 2nd sensor (t_{min}; t_{max}; $t_{reference}$), e.g. 100; 250; 150 Lines 3 and 4: Specify resistance in Ω at 0°C; permissible values are 100 and 1000, multiplied or divided by a whole number e.g: 1000 : 4 = 250, 100 : 2 = 50 or 100 x 3 = 300</p>							

--	--	--	--	--	--	--	--

↑ Insert code in the
↑ 1st box of the
↑ next page!

Feature "6. Sensor type / Temperature range" continued on next page!

© Ziegler Instruments Order No. V604 Data sheet-EI.R0-920828-47-2013-EN

Order Code 604 -												
Features, Selection						*SCODE	no-go					
6.Sensor type / Temperature range (continuation)												
B)	Type B:	Pt30Rh-Pt6Rh	[°C]			CEFTZ	B	
E)	Type E:	NiCr-CuNi	[°C]			CEFZ	E	
J)	Type J:	Fe-CuNi	[°C]			CEFZ	J	
K)	Type K:	NiCr-Ni	[°C]			CEFZ	K	
L)	Type L:	Fe-CuNi	[°C]			CEFZ	L	
N)	Type N:	NiCrSi-NiSi	[°C]			CEFZ	N	
R)	Type R:	Pt13Rh-Pt	[°C]			CEFZ	R	
S)	Type S:	Pt10Rh-Pt	[°C]			CEFZ	S	
T)	Type T:	Cu-CuNi	[°C]			CEFZ	T	
U)	Type U:	Cu-CuNi	[°C]			CEFZ	U	
W)	Type W5-W26Re		[°C]			CEFZ	W	
Lines B to W: Specify measuring range in [°C] or F ⁰ ; refer to Table 8 for the operating limits for each type of sensor. For temperature difference measurement: specify measuring range and reference temperature for 2nd sensor (t _{min} ; t _{max} ; t _{reference}), e.g. 100; 250; 150												
7.Output signal / Measuring output A1*												
0)	0...20 mA, R _{ext} ≤ 750 Ω						.	0	.	.	.	
1)	4...20 mA, R _{ext} ≤ 750 Ω					Z	.	1	.	.	.	
2)	Non-standard		[mA]			Z	.	2	.	.	.	
3)	0... 5 V, R _{ext} ≥ 250 Ω					Z	.	3	.	.	.	
4)	1... 5 V, R _{ext} ≥ 250 Ω					Z	.	4	.	.	.	
5)	0...10 V, R _{ext} ≥ 500 Ω					Z	.	5	.	.	.	
6)	2...10 V, R _{ext} ≥ 500 Ω					Z	.	6	.	.	.	
7)	Non-standard		[V]			Z	.	7	.	.	.	
Line 2: -22 to + 22, span 5 to 40 mA Line 7: -12 to + 15, span 4 to 27 V												
8.Output characteristic												
0)	Directly proportional, initial start-up value 0%						.	.	0	.	.	
1)	Inversely proportional, initial start-up value 100%					Z	.	.	1	.	.	
2)	Directly proportional, initial start-up value		[%]			Z	.	.	2	.	.	
3)	Inversely proportional, initial start-up value		[%]			Z	.	.	3	.	.	
9.Output time response												
0)	Rated settling time approx. 1s						.	.	.	0	.	
1)	Others		[s]			Z	.	.	.	1	.	
Line 1: Any whole number from 2 to 30 s												

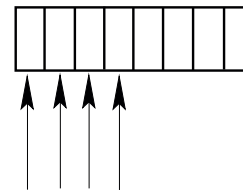

* 2nd output signal A2 for field indicator only

Order Code 604 -												
Features, Selection	*SCODE	no-go										
10. Open-circuit sensor signalling												
Without / open-circuit sensor signal/ relay / output signalA corresponding to input variable[%]												
0) Nosensorsignal(forcurrentorvoltage measurement)		DEF	0									
1) Withsensorsignal/relaydisabled/ output signalA % <input type="text"/>		CZ	1									
2) Withsensorsignal/relayenergized/ output signalA % <input type="text"/>	K	CZ	2									
3) Withsensorsignal/relayde-energized/ output signalA % <input type="text"/>	K	CZ	3									
4) Withsensorsignal/relayenergized/holdAatlastvalue	K	CZ	4									
5) Withsensorsignal/relayde-energized/holdAatlastvalue	K	CZ	5									
Lines 1, 2 and 3: Specify value of outputsignal span in %, any value from -10%to110%; e.g.with output4...20 mA corresponding 2.4 mA-10% and 21.6 mA 110%												
Lines 2 to5: Cannotbe combined with active trip point GW, Feature 12.lines 1 to3 and Feature 13.lines 1 and 2												
11. Mains ripple suppression												
0) Frequency 50 Hz			. 0									
1) Frequency60Hz		Z	. 1									
12. Type and values of trippoint GW and resetratio, energizing delay and de-energizing delay of the relay (foroutput contact K)												
0) Alarmfunctioninactive	L		. . 0									
1) Lowalarm [%;%;s;s]	M	KZ	. . 1									
2) Highalarm [%;%;s;s]	M	KZ	. . 2									
3) Rate-of-changealarmdx/dt [%/s;%;s;s]	M	KZ	. . 3									
13. Sense of action of trip point (for GW resp.K)												
0) Alarmfunctioninactive		M	. . . 0									
1) Relayenergizedinalarmcondition		KLZ	. . . 1									
2) Relayenergizedinsafecondition		KLZ	. . . 2									

* Lines withletter(s)under“no-go” cannotbe combined withpreceding lineshaving the same letter under “SCODE”.

Important condition: The V 604 may onlybe programmed using a **ATEX 2082 U**.

PRKAB600 with the component certificate**PTB 97**

ZIEGLER INSTRUMENTS

Schnepfenreuther Weg 6, D-90425 Nürnberg, Germany.

TEL. | (+49)(911) 38 492 45 | E-MAIL | info@ziegler-instruments.com
 FAX. | (+49)(911) 32 26 212 | WEBSITE | www.ziegler-instruments.com



Ziegler

Redefine Innovative Metering